

STAND-ALONE UNIT
FOR HUMIDITY AND TEMPERATURE
CONTROL
CCV CCA CCW

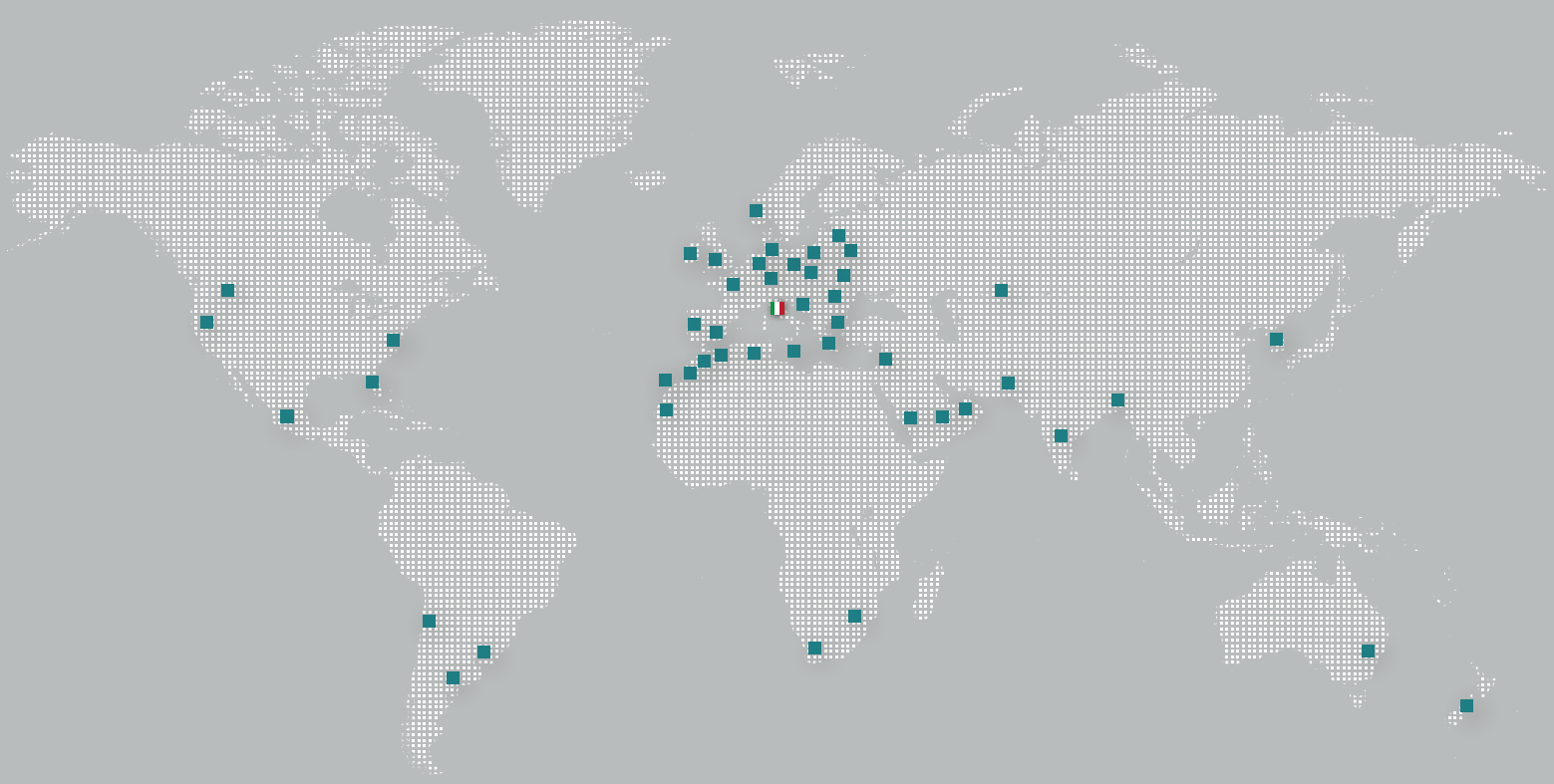

HiDew

Dehumidifiers **10th**



DISTRIBUTION:

EXPORT TO MORE THAN 50 COUNTRIES

WINES AND FOODS

Controlling the temperature and humidity values inside an high quality food or wine cellar ensure proper conservation. Aromas and flavors will be preserved.

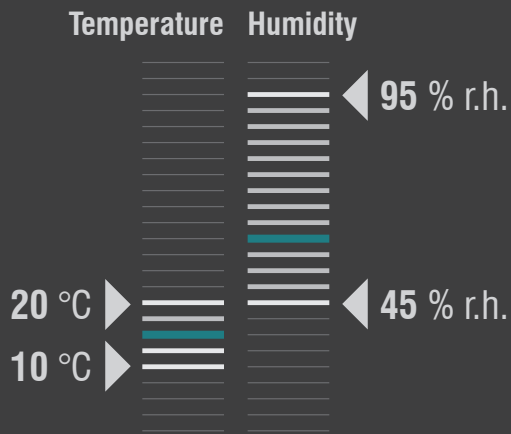

TECHNICAL LABORATORIES

Technology laboratories are environments in which temperatures and humidity conditions must be controlled to ensure maximum performance of instruments

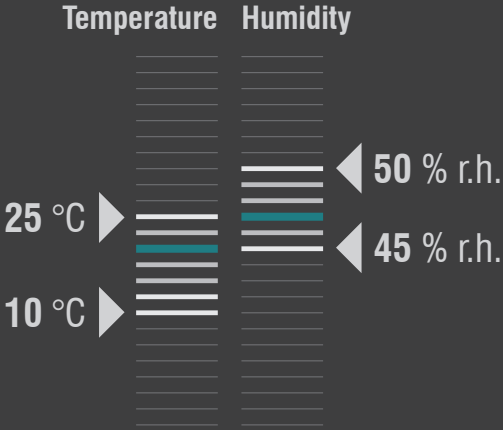

FURNITURE, ART, CLOTHES

Works of art, whether paintings or furniture, and clothing, whether antique or precious, depend on the thermo hygrometric conditions of the environment in which they are located.

Canvas, paper, wood, fabric are materials that can change in shape and quality if they are not in temperature and humidity controlled environments.

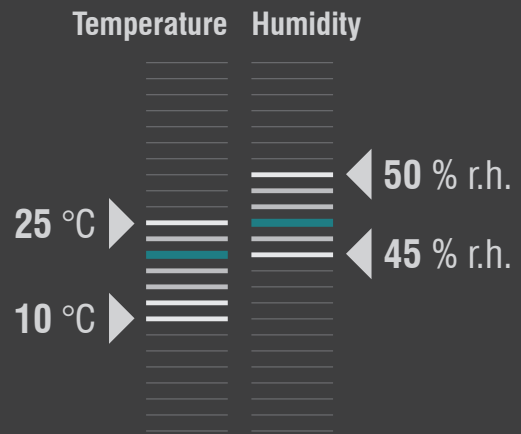

MODES AND OPERATING LIMITS

The unit can control temperature and relative humidity thanks to on-board mounted probes.

Five working modes:

- **Ventilation:** air treatments are off, only fans are working
- **Dehumidification:** the compressor is on and the air is dehumidified
- **Humidification:** the humidification module is activated
- **Heating:** the electrical resistance is on
- **Cooling:** the compressor is on, the air is dehumidified and cooled

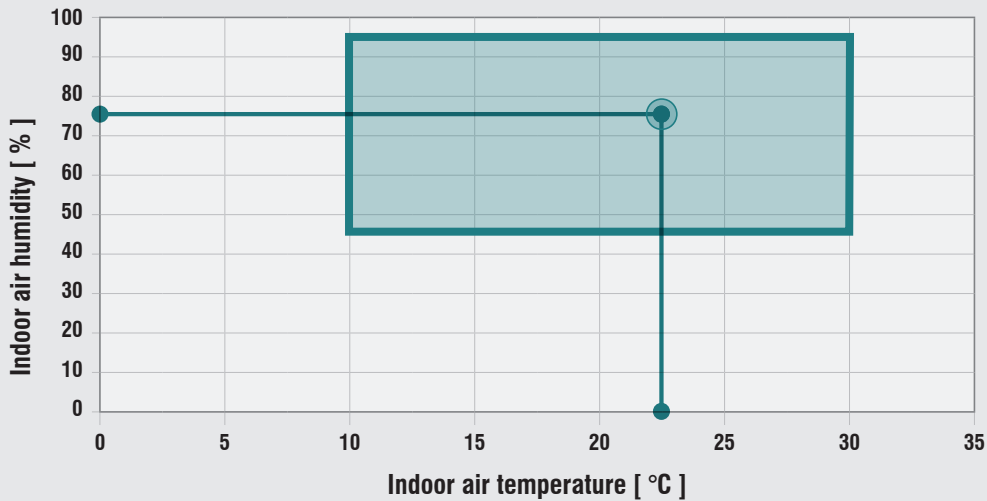
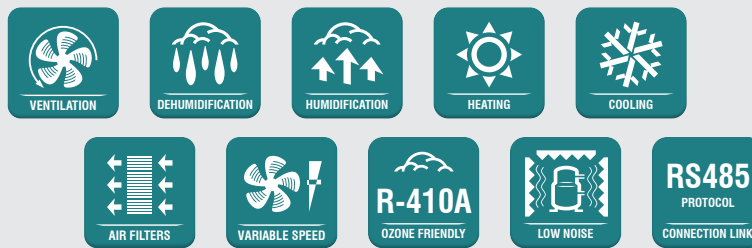

VERSIONS

CCV

AIR-COOLED MONOBLOCK

CCA

AIR-COOLED SPLIT

CCW

WATER-COOLED MONOBLOCK

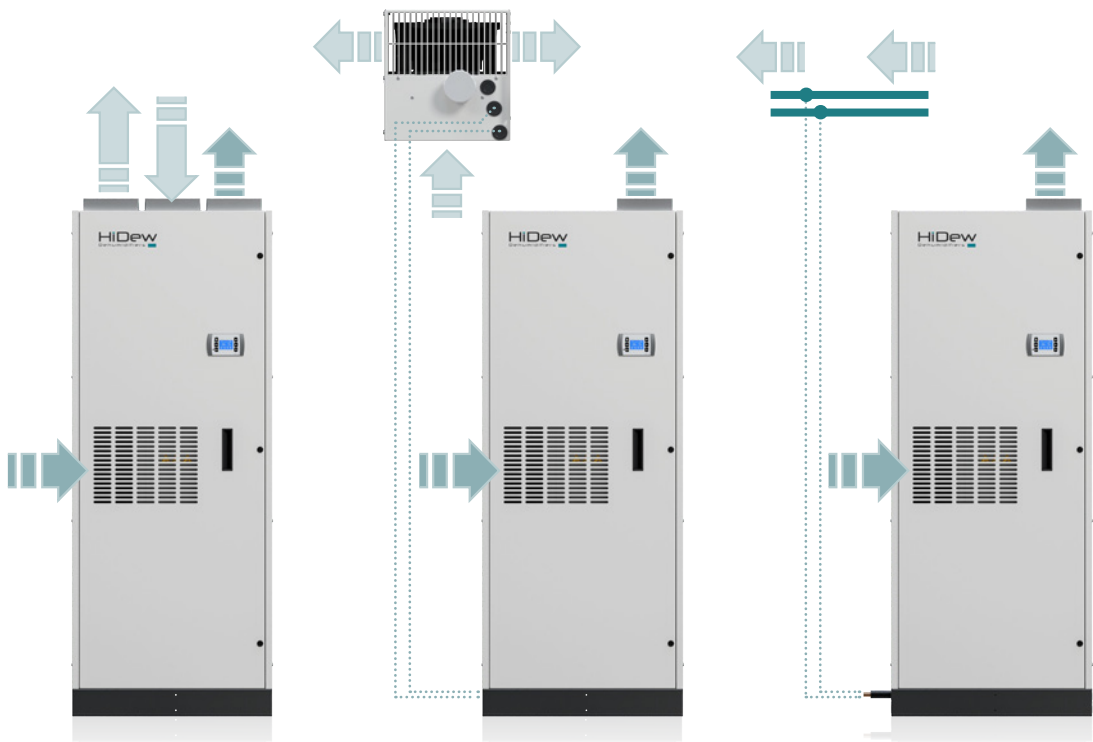

VERSIONS WITH BOTTOM INTAKE FOR FLOATING FLOORS (Opt.)

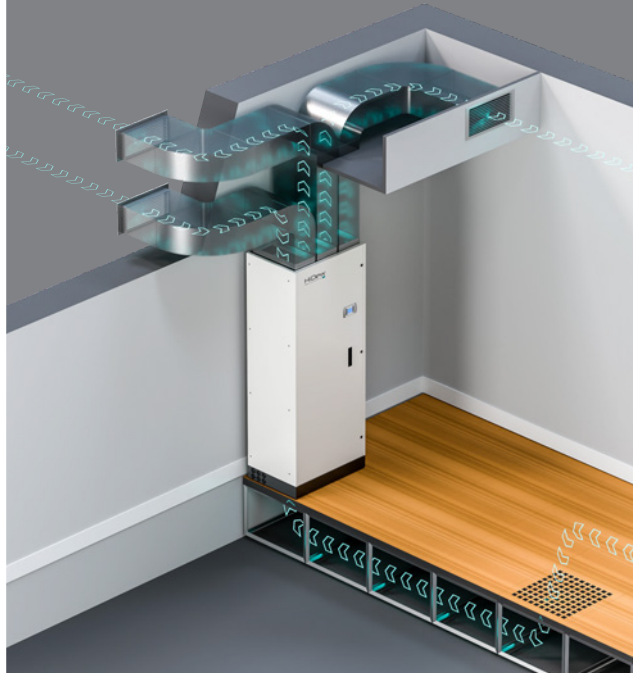

REAR INTAKE IDEAL FOR THE TECHNICAL COMPARTMENT (Opt.)

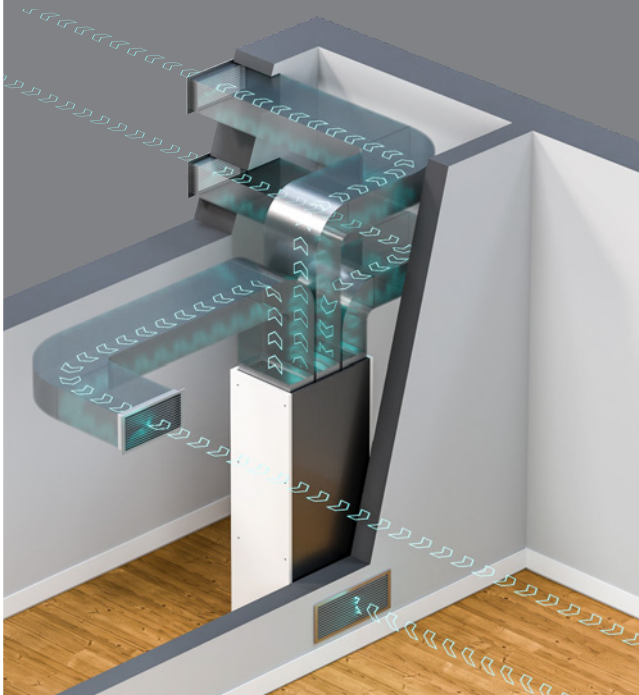

CCV

AIR-COOLED
MONOBLOCK



CCA

AIR-COOLED
SPLIT



CCW

WATER-COOLED
MONOBLOCK



CCV CCA CCW

SUCTION FROM
THE BACK
(Opt.)

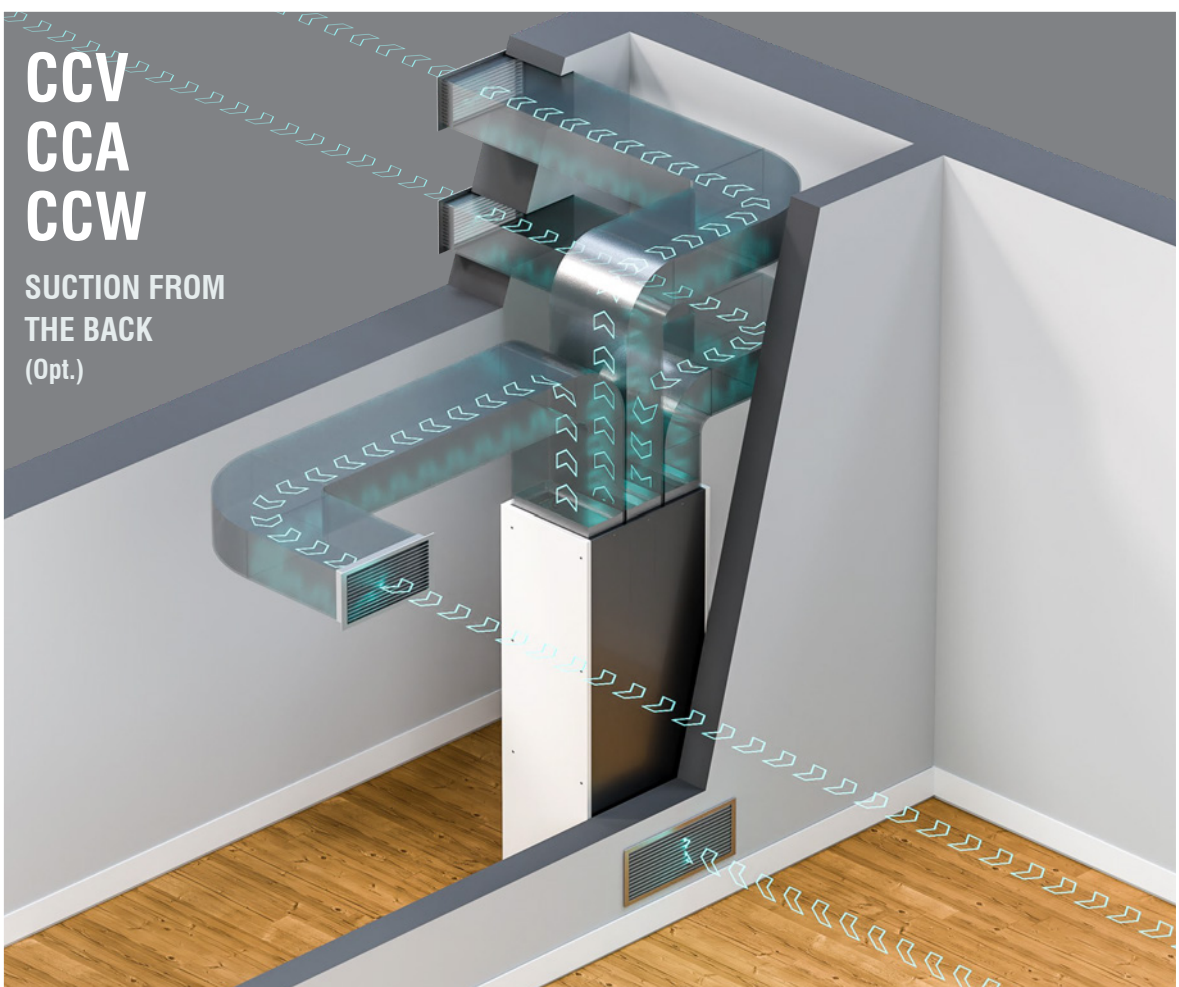

UNIT AND COMPONENT DESCRIPTION

HIGH CONSTRUCTION QUALITY FOR LONG SERVICE LIFE AND LOW ENERGY CONSUMPTION

CCV



Advanced electronic control with clock card and time bands. A mounted on board display is provided that allows to control the unit.

Rectangular flanges (Opt.) to replace standard circular nozzles to adapt to different ducting systems.

Painted condensing coil with copper pipes and aluminum fins.

Backward-bladed EC fans directly coupled to brushless motors and regulated by 0/10 Volts signal. they ensure lower power consumptions and lower sound power output.

Post-heating electrical heater (Opt.) modulating according to air flow.

Painted evaporating coil with copper pipes and aluminum fins, complete with stainless steel condensate drain tray.

G2 filter as standard or F6 filter as option positioned in the recirculation duct and the intake of the outdoor air. The filtering capacity is ISO Coarse 70% (G2) Standard; it is possible to install filters up to ISO ePM10 60% (F6) in the recirculation section.

Steam humidifier (Opt.) capacity 3 kg/h.

Rotary type compressor, thermally protected. There are crankcase heaters for oil pre-heating.

The outdoor condenser is equipped with modulating electronic fans that can adjust the flow rate according to the condensing temperature.

CCA

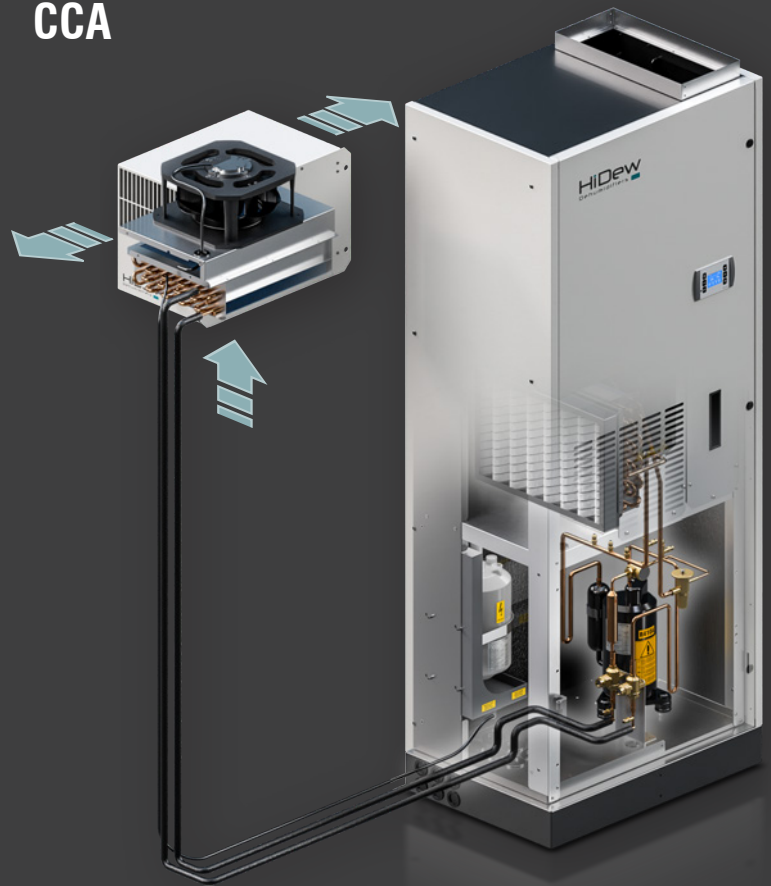

Integrated plate exchanger with water side modulating valve included to optimize condensing pressure.

CCW

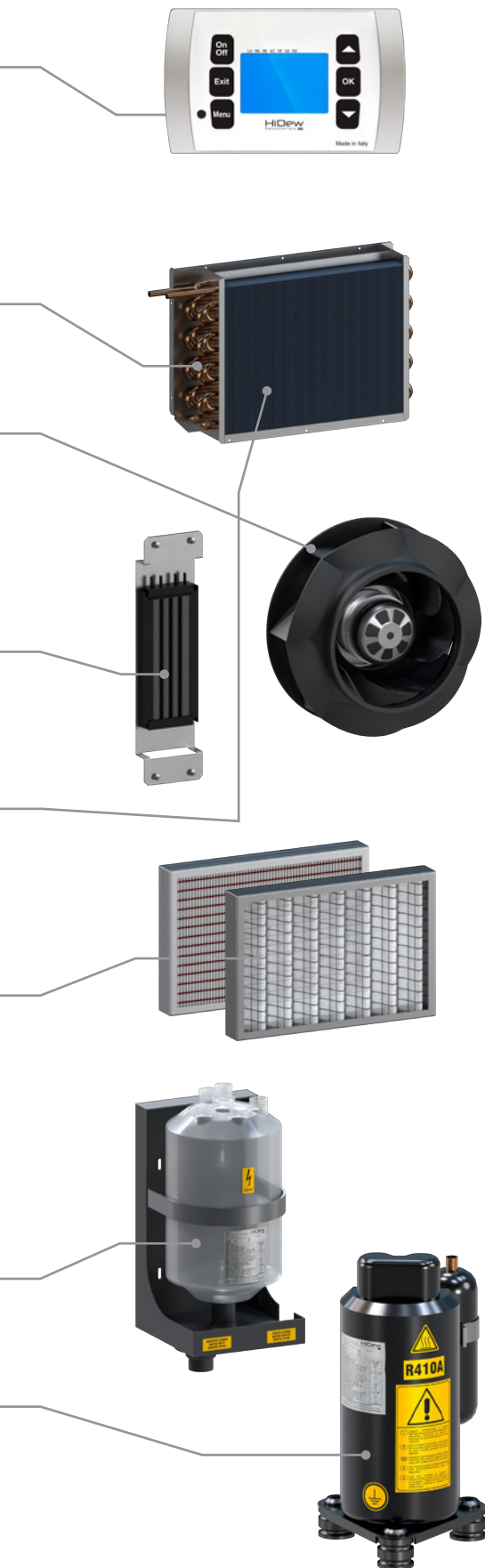
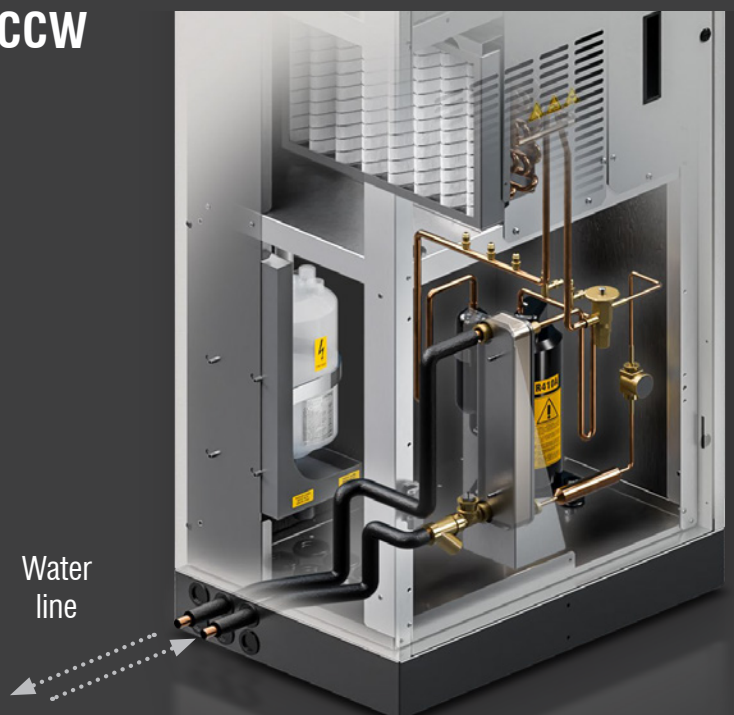

ADVANCED ELECTRONIC CONTROL

All units are operated by an advanced electronic control with a clock and time zone card. An on-board mounted display is provided to control the unit.



Management and optimization software for the refrigeration cycle, electronic and electromechanical components is implemented and developed in-house, with the following functions:

- Set unit control: manual or time bands
- Time slot programming on 7 daily programs, 24 time slots per day: unit ON/OFF, desired temperature, desired relative humidity
- Alarm management
- Remote ON/OFF management
- Water supply management to the unit (CCW)
- Modbus RS485 serial board as standard

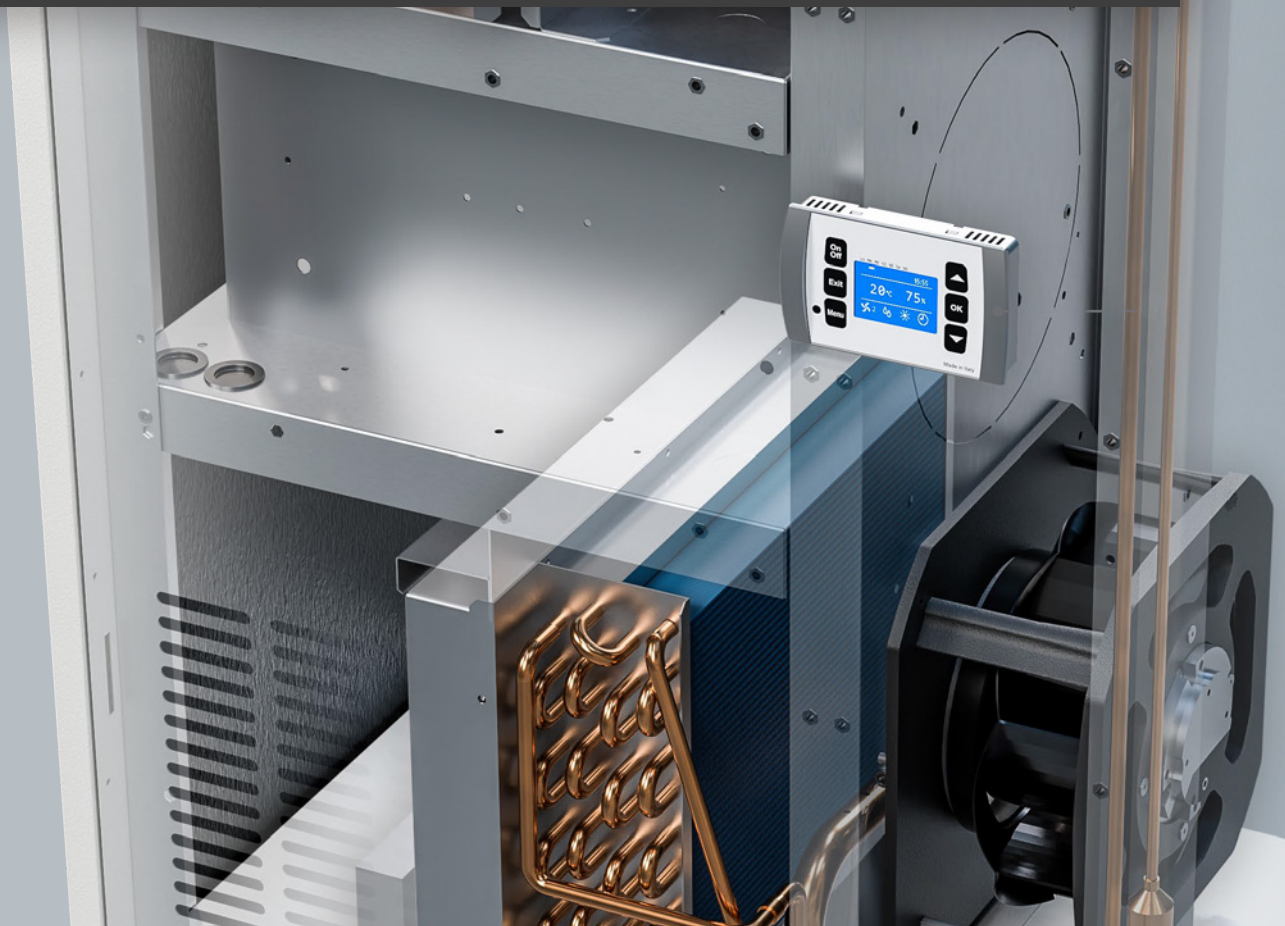

DIMENSIONS AND CLEARANCE SPACES

CCV / CCA / CCW standard

	DIMENSIONS			CLEARANCE SPACES		
	A [mm]	B [mm]	C [mm]	E [mm]	F [mm]	G [mm]
CCV / CCA / CCW 300	450	650	1690	200	700	200
CCV / CCA / CCW 450	450	650	1690	200	700	200
CCA / CCW 900	450	650	1690	200	700	200

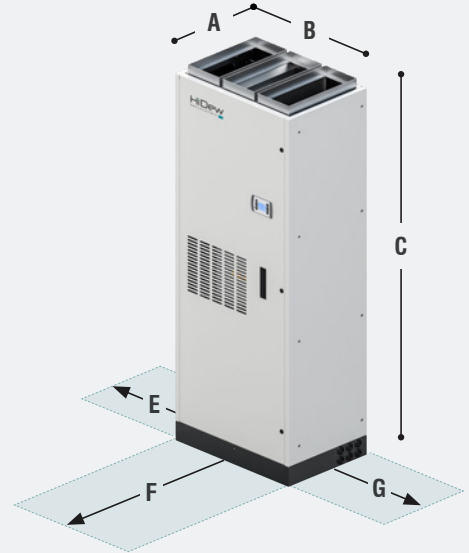

External condenser CCA

	DIMENSIONS			CLEARANCE SPACES				
	A [mm]	B [mm]	C [mm]	E [mm]	F [mm]	G [mm]	H [mm]	I [mm]
300	286	463	300	500	500	500	400	800
450	286	463	300	500	500	500	400	800
900	403	616	408	500	600	500	400	800

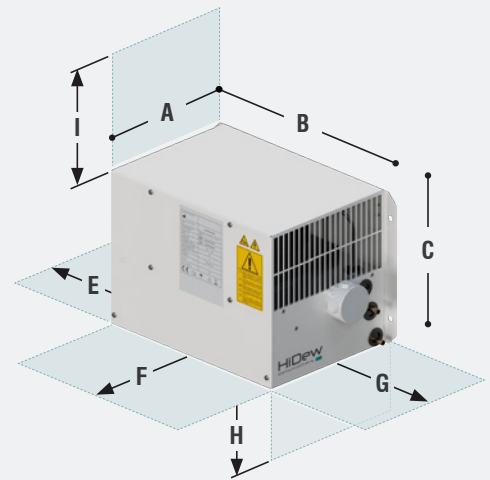

CONFIGURATIONS MODELS

	300	450	900
CCV			
CCA			
CCW			

TECHNICAL FEATURES

		Model size: ▶	CCV 300	CCA 300	CCW 300
TOTAL COOLING CAPACITY	W		1450	1500	1550
SENSIBLE COOLING CAPACITY	W		840	840	840
SUPPLY AIR FLOW	m³/h		300		
EXTERNAL CONDENSATION AIR FLOW	m³/h		Modulating from 0 to 350		-
SUPPLY AIR FAN AVAILABLE STATIC PRESSURE	Pa		180		
EXTERNAL AIR FAN AVAILABLE STATIC PRESSURE	Pa		150	220	-
ELECTRIC HEATER NOMINAL CAPACITY	W		1300		
NOMINAL HUMIDIFIER CAPACITY	W		1575		
HUMIDIFIER FLOW RATE	Kg/h		5		
NOMINAL POWER CONSUMPTION WITHOUT OPTIONS	W		600		500
MAXIMUM POWER CONSUMPTION WITHOUT OPTIONS	W		900		700
MAXIMUM ABSORBED POWER WITH ONLY RESISTANCE	W		2200		2000
MAXIMUM ABSORBED POWER WITH HUMIDIFIER ONLY	W		3200		3000
ABSORBED POWER MAX WITH RESISTANCE AND HUMIDIFIER	W		4500		4300
DIMENSIONS	mm		650 x 1690 x 450		
WEIGHT	Kg		85		
REFRIGERANT GAS	Type		R410A		
POWER SUPPLY	V/Ph/Hz		230 / 1 + N / 50 400 / 3 + N / 50 (Opt.)		
CONDENSATION WATER FLOW	m³/h		-	-	0,51
CONDENSING WATER TEMPERATURE LIMITS	°C		-	-	From +10 to +35
CONDENSING AIR TEMPERATURE LIMITS	°C		-	From -5 to +35	-
EXTERNAL CONDENSER DIMENSIONS	mm		-	463 x 300 x 286	-
EXTERNAL CONDENSING WEIGHT	Kg		-	15	-

The cooling capacity is declared with an internal environment at 18 ° C / 80% r.h. and external air 30 ° C for CCV and CCA units.
The cooling capacity is declared with an internal environment at 18 ° C / 80% r.h. and water supplied at 15 ° C for CCW units.

PERFORMANCE CCV / CCA 300 (CCW: performance on demand)

CCV / CCA 300		Outside air temperature °C							
		20				25			
Inlet air Temperature °C	Inlet air Humidity % R.H.	Total cooling Capacity kW	Sensible cooling capacity kW	Dehumi-dification capacity l/24h	Compressor absorbed power kW	Total cooling Capacity kW	Sensible cooling capacity kW	Dehumi-dification capacity l/24h	Compressor absorbed power kW
12	50	1,32	1,17	5,2	0,35	1,28	1,15	4,5	0,41
	60	1,37	1,08	10,0	0,35	1,32	1,05	9,3	0,41
	70	1,4	0,98	14,4	0,35	1,35	0,94	14,1	0,41
	80	1,44	0,87	19,6	0,36	1,4	0,84	19,3	0,42
15	50	1,43	1,23	6,9	0,36	1,39	1,21	6,2	0,42
	60	1,49	1,12	12,7	0,36	1,45	1,09	12,4	0,42
	70	1,53	1	18,2	0,37	1,48	0,97	17,5	0,43
	80	1,57	0,89	23,4	0,37	1,53	0,87	22,7	0,43
18	50	1,56	1,27	10,0	0,37	1,51	1,26	8,6	0,43
	60	1,6	1,14	15,8	0,37	1,55	1,12	14,8	0,44
	70	1,66	1,02	22,0	0,37	1,58	0,98	20,6	0,45
	80	1,71	0,89	28,2	0,38	1,63	0,86	26,5	0,45
20	50	1,63	1,31	11,0	0,38	1,57	1,28	10,0	0,44
	60	1,69	1,17	17,9	0,38	1,63	1,14	16,9	0,45
	70	1,75	1,03	24,8	0,38	1,69	1	23,7	0,45
	80	1,8	0,89	31,3	0,39	1,73	0,86	29,9	0,45
25	50	1,84	1,38	15,8	0,4	1,76	1,34	14,4	0,47
	60	1,9	1,19	24,4	0,41	1,83	1,17	22,7	0,47
	70	1,96	1,02	32,3	0,42	1,88	1	30,3	0,47
	80	2,03	0,87	39,9	0,42	1,95	0,84	38,2	0,47
CCV / CCA 300		Outside air temperature °C							
		30				35			
Inlet air Temperature °C	Inlet air Humidity % R.H.	Total cooling Capacity kW	Sensible cooling capacity kW	Dehumi-dification capacity l/24h	Compressor absorbed power kW	Total cooling Capacity kW	Sensible cooling capacity kW	Dehumi-dification capacity l/24h	Compressor absorbed power kW
12	50	1,25	1,13	4,1	0,46	1,2	1,1	3,4	0,53
	60	1,28	1,02	8,9	0,46	1,23	1	7,9	0,53
	70	1,3	0,92	13,1	0,48	1,26	0,9	12,4	0,53
	80	1,34	0,82	17,9	0,47	1,31	0,81	17,2	0,53
15	50	1,35	1,19	5,5	0,47	1,3	1,14	5,5	0,53
	60	1,39	1,06	11,4	0,47	1,35	1,01	11,7	0,54
	70	1,44	0,95	16,9	0,48	1,38	0,92	15,8	0,54
	80	1,47	0,84	21,7	0,48	1,42	0,81	21,0	0,54
18	50	1,45	1,23	7,6	0,49	1,41	1,21	6,9	0,54
	60	1,5	1,1	13,8	0,5	1,44	1,07	12,7	0,55
	70	1,54	0,96	20,0	0,5	1,5	0,94	19,3	0,55
	80	1,58	0,84	25,5	0,51	1,54	0,83	24,4	0,55
20	50	1,53	1,26	9,3	0,49	1,47	1,23	8,3	0,55
	60	1,57	1,11	15,8	0,5	1,52	1,09	14,8	0,56
	70	1,63	0,97	22,7	0,5	1,56	0,94	21,3	0,56
	80	1,67	0,83	28,9	0,51	1,6	0,81	27,2	0,56
25	50	1,7	1,32	13,1	0,78	1,65	1,3	12,0	0,57
	60	1,76	1,14	21,3	0,78	1,71	1,12	20,3	0,57
	70	1,83	0,98	29,2	0,79	1,76	0,95	27,9	0,57
	80	1,88	0,82	36,5	0,81	1,82	0,8	35,1	0,57

TECHNICAL FEATURES

		Model size: ▶	CCV 450	CCA 450	CCW 450
TOTAL COOLING CAPACITY	W		2150	2200	2250
SENSIBLE COOLING CAPACITY	W		1200	1200	1200
SUPPLY AIR FLOW	m³/h		450		
EXTERNAL CONDENSATION AIR FLOW	m³/h		Modulating from 0 to 500		-
SUPPLY AIR FAN AVAILABLE STATIC PRESSURE	Pa		180		
EXTERNAL AIR FAN AVAILABLE STATIC PRESSURE	Pa		150	220	-
ELECTRIC HEATER NOMINAL CAPACITY	W		1300		
NOMINAL HUMIDIFIER CAPACITY	W		1575		
HUMIDIFIER FLOW RATE	Kg/h		5		
NOMINAL POWER CONSUMPTION WITHOUT OPTIONS	W		800		700
MAXIMUM POWER CONSUMPTION WITHOUT OPTIONS	W		1100		1000
MAXIMUM ABSORBED POWER WITH ONLY RESISTANCE	W		2400		2300
MAXIMUM ABSORBED POWER WITH HUMIDIFIER ONLY	W		3400		3200
ABSORBED POWER MAX WITH RESISTANCE AND HUMIDIFIER	W		4700		4500
DIMENSIONS	mm		650 x 1690 x 450		
WEIGHT	Kg		90		
REFRIGERANT GAS	Type		R410A		
POWER SUPPLY	V/Ph/Hz		230 / 1 + N / 50 400 / 3 + N / 50 (Opt.)		
CONDENSATION WATER FLOW	m³/h		-	-	0,51
CONDENSING WATER TEMPERATURE LIMITS	°C		-	-	From +10 to +35
CONDENSING AIR TEMPERATURE LIMITS	°C		-	From -5 to +35	-
EXTERNAL CONDENSER DIMENSIONS	mm		-	463 x 300 x 286	-
EXTERNAL CONDENSING WEIGHT	Kg		-	15	-

The cooling capacity is declared with an internal environment at 18 ° C / 80% r.h. and external air 30 ° C for CCV and CCA units.
The cooling capacity is declared with an internal environment at 18 ° C / 80% r.h. and water supplied at 15 ° C for CCW units.

PERFORMANCE CCA / CCV 450 (CCW: performance on demand)

CCV / CCA 450		Outside air temperature °C							
		20				25			
Inlet air Temperature °C	Inlet air Humidity % R.H.	Total cooling Capacity kW	Sensible cooling capacity kW	Dehumidification capacity l/24h	Compressor absorbed power kW	Total cooling Capacity kW	Sensible cooling capacity kW	Dehumidification capacity l/24h	Compressor absorbed power kW
12	50	1,9	1,71	6,5	0,54	1,84	1,68	5,5	0,62
	60	1,96	1,56	13,8	0,55	1,9	1,52	13,1	0,63
	70	2	1,4	20,6	0,55	1,96	1,38	20,0	0,63
	80	2,07	1,26	27,9	0,55	2,01	1,23	26,8	0,64
15	50	2,07	1,8	9,3	0,56	2	1,76	8,3	0,65
	60	2,13	1,62	17,5	0,56	2,06	1,58	16,5	0,65
	70	2,2	1,45	25,8	0,57	2,11	1,4	24,4	0,66
	80	2,26	1,28	33,7	0,58	2,19	1,25	32,3	0,66
18	50	2,21	1,86	12,0	0,59	2,15	1,83	11,0	0,66
	60	2,31	1,67	22,0	0,59	2,22	1,62	20,6	0,68
	70	2,37	1,47	31,0	0,6	2,3	1,44	29,6	0,68
	80	2,44	1,28	39,9	0,6	2,37	1,25	38,5	0,68
20	50	2,33	1,9	14,8	0,6	2,26	1,87	13,4	0,68
	60	2,41	1,68	25,1	0,6	2,34	1,65	23,7	0,68
	70	2,5	1,48	35,1	0,61	2,4	1,44	33,0	0,69
	80	2,57	1,28	44,4	0,61	2,49	1,25	42,7	0,69
25	50	2,61	1,99	21,3	0,63	2,53	1,96	19,6	0,7
	60	2,72	1,73	34,1	0,64	2,64	1,7	32,3	0,71
	70	2,81	1,48	45,8	0,65	2,7	1,44	43,3	0,73
	80	2,88	1,25	56,1	0,66	2,83	1,23	55,0	0,74
		Outside air temperature °C							
		30				35			
Inlet air Temperature °C	Inlet air Humidity % R.H.	Total cooling Capacity kW	Sensible cooling capacity kW	Dehumidification capacity l/24h	Compressor absorbed power kW	Total cooling Capacity kW	Sensible cooling capacity kW	Dehumidification capacity l/24h	Compressor absorbed power kW
12	50	1,77	1,64	4,5	0,71	1,71	1,6	3,8	0,79
	60	1,84	1,5	11,7	0,71	1,77	1,45	11,0	0,79
	70	1,86	1,32	18,6	0,71	1,82	1,3	17,9	0,8
	80	1,93	1,19	25,5	0,71	1,87	1,15	24,8	0,81
15	50	1,94	1,73	7,2	0,73	1,86	1,69	5,8	0,81
	60	2	1,55	15,5	0,73	1,92	1,51	14,1	0,82
	70	2,05	1,37	23,4	0,74	1,98	1,34	22,0	0,82
	80	2,13	1,22	31,3	0,73	2,04	1,17	29,9	0,82
18	50	2,08	1,79	10,0	0,74	2,01	1,76	8,6	0,82
	60	2,17	1,6	19,6	0,74	2,08	1,56	17,9	0,82
	70	2,21	1,39	28,2	0,76	2,14	1,36	26,8	0,84
	80	2,25	1,2	36,1	0,76	2,2	1,18	35,1	0,84
20	50	2,19	1,84	12,0	0,74	2,09	1,79	10,3	0,84
	60	2,29	1,63	22,7	0,74	2,17	1,58	20,3	0,84
	70	2,33	1,4	32,0	0,76	2,25	1,37	30,3	0,85
	80	2,39	1,21	40,6	0,76	2,29	1,16	38,9	0,86
25	50	2,42	1,92	17,2	0,78	2,34	1,88	15,8	0,86
	60	2,51	1,65	29,6	0,79	2,42	1,62	27,5	0,87
	70	2,61	1,41	41,3	0,81	2,5	1,37	38,9	0,88
	80	2,68	1,18	51,6	0,81	2,57	1,14	49,2	0,89

TECHNICAL FEATURES

		Model size: ▶	CCA 900	CCW 900
TOTAL COOLING CAPACITY	W		4400	4600
SENSIBLE COOLING CAPACITY	W		2440	2440
SUPPLY AIR FLOW	m³/h		900	
EXTERNAL CONDENSATION AIR FLOW	m³/h		Modulating from 0 to 950	
SUPPLY AIR FAN AVAILABLE STATIC PRESSURE	Pa		200	
EXTERNAL AIR FAN AVAILABLE STATIC PRESSURE	Pa		220	
ELECTRIC HEATER NOMINAL CAPACITY	W		2600	
NOMINAL HUMIDIFIER CAPACITY	W		1800	
HUMIDIFIER FLOW RATE	Kg/h		5	
NOMINAL POWER CONSUMPTION WITHOUT OPTIONS	W		1500	1400
MAXIMUM POWER CONSUMPTION WITHOUT OPTIONS	W		2200	1900
MAXIMUM ABSORBED POWER WITH ONLY RESISTANCE	W		4800	4500
MAXIMUM ABSORBED POWER WITH HUMIDIFIER ONLY	W		4500	4100
ABSORBED POWER MAX WITH RESISTANCE AND HUMIDIFIER	W		7100	6700
DIMENSIONS	mm		650 x 1690 x 450	
WEIGHT	Kg		95	
REFRIGERANT GAS	Type		R410A	
POWER SUPPLY	V/Ph/Hz		230 / 1 + N / 50 400 / 3 + N / 50 (Opt.)	
CONDENSATION WATER FLOW	m³/h		-	1,05
CONDENSING WATER TEMPERATURE LIMITS	°C		-	From +10 to +35
CONDENSING AIR TEMPERATURE LIMITS	°C		From -5 to +35	
EXTERNAL CONDENSER DIMENSIONS	mm		286 x 463 x 300	403 x 616 x 408
EXTERNAL CONDENSING WEIGHT	Kg		25	-

The cooling capacity is declared with an internal environment at 18 ° C / 80% r.h. and external air 30 ° C for CCA units.

The cooling capacity is declared with an internal environment at 18 ° C / 80% r.h. and water supplied at 15 ° C for CCW units.

PERFORMANCE CCA 900 (CCW: performance on demand)

CCA 900		Outside air temperature °C							
		20				25			
Inlet air Temperature °C	Inlet air Humidity % R.H.	Total cooling Capacity kW	Sensible cooling capacity kW	Dehumidification capacity l/24h	Compressor absorbed power kW	Total cooling Capacity kW	Sensible cooling capacity kW	Dehumidification capacity l/24h	Compressor absorbed power kW
12	50	3,84	3,45	13,4	1,05	3,73	3,38	12,0	1,2
	60	3,97	3,15	28,2	1,06	3,85	3,08	26,5	1,22
	70	4,08	2,85	42,3	1,06	3,92	2,76	39,9	1,24
	80	4,18	2,55	56,1	1,08	4,06	2,49	54,0	1,24
15	50	4,18	3,62	19,3	1,08	4,05	3,55	17,2	1,24
	60	4,3	3,25	36,1	1,11	4,17	3,19	33,7	1,25
	70	4,44	2,92	52,3	1,11	4,31	2,85	50,2	1,27
	80	4,56	2,59	67,8	1,14	4,43	2,52	65,7	1,27
18	50	4,5	3,76	25,5	1,13	4,37	3,69	23,4	1,28
	60	4,66	3,36	44,7	1,16	4,53	3,29	42,7	1,3
	70	4,79	2,96	63,0	1,17	4,65	2,89	60,5	1,31
	80	4,93	2,59	80,5	1,17	4,79	2,52	78,1	1,33
20	50	4,74	3,85	30,6	1,16	4,56	3,76	27,5	1,3
	60	4,91	3,41	51,6	1,16	4,73	3,33	48,2	1,33
	70	5,05	2,98	71,2	1,19	4,9	2,92	68,1	1,33
	80	5,19	2,58	89,8	1,2	5,04	2,52	86,7	1,35
25	50	5,26	4	43,3	1,24	5,11	3,94	40,2	1,36
	60	5,45	3,47	68,1	1,27	5,28	3,41	64,3	1,39
	70	5,67	2,99	92,2	1,27	5,45	2,9	87,7	1,41
	80	5,83	2,51	114,2	1,28	5,66	2,46	110,1	1,42
CCA 900		Outside air temperature °C							
		30				35			
Inlet air Temperature °C	Inlet air Humidity % R.H.	Total cooling Capacity kW	Sensible cooling capacity kW	Dehumidification capacity l/24h	Compressor absorbed power kW	Total cooling Capacity kW	Sensible cooling capacity kW	Dehumidification capacity l/24h	Compressor absorbed power kW
12	50	3,61	3,31	10,3	1,36	3,45	3,22	8,0	1,52
	60	3,69	2,99	24,1	1,38	3,57	2,92	22,4	1,53
	70	3,8	2,69	38,2	1,39	3,68	2,63	36,1	1,55
	80	3,9	2,4	51,6	1,39	3,77	2,33	49,5	1,55
15	50	3,89	3,46	14,8	1,39	3,76	3,39	12,7	1,55
	60	4	3,1	31,0	1,41	3,87	3,03	28,9	1,58
	70	4,14	2,76	47,5	1,42	4	2,7	44,7	1,58
	80	4,25	2,43	62,6	1,44	4,11	2,37	59,9	1,58
18	50	4,2	3,6	20,6	1,42	4,06	3,54	17,9	1,58
	60	4,35	3,2	39,6	1,45	4,2	3,14	36,5	1,61
	70	4,46	2,81	56,8	1,49	4,32	2,72	55,0	1,61
	80	4,6	2,44	74,3	1,5	4,45	2,37	71,6	1,63
20	50	4,42	3,7	24,8	1,45	4,27	3,63	22,0	1,61
	60	4,58	3,26	45,4	1,49	4,38	3,17	41,6	1,64
	70	4,71	2,83	64,7	1,49	4,55	2,77	61,2	1,64
	80	4,84	2,43	82,9	1,5	4,78	2,41	81,5	1,58
25	50	4,94	3,87	36,8	1,52	4,84	3,83	34,7	1,59
	60	5,12	3,34	61,2	1,53	5,01	3,3	59,0	1,61
	70	5,28	2,84	83,9	1,55	5,17	2,8	81,5	1,63
	80	5,42	2,37	104,9	1,58	5,31	2,34	102,2	1,64

HiDew
Dehumidifiers 10th

HiDew S.r.l.

Headquarter : Via dell'Artigianato, 5 35026 Conselve (PD) - Italy
Phone: +39 049 9502511

Registered Office : Viale Spagna, 31/33 35020 Tribano (PD) - Italy
Phone: +39 049 9588511 Fax: +39 049 9588522

www.hidew.it info@hidew.it



HD-CCVEN-2022

MADE IN ITALY



HiDew S.r.l. reserves the right to change the specifications and other information contained herein without notice. No part of this publication may be reproduced without the prior written permission of HiDew S.r.l.